



HOT ROCKS

USER MANUAL

Keep this manual with the oven. This is the property of the end user.



SERIAL NUMBER



FOR SUPPORT
service@hotrocksoven.com

1 800 668-1883

TABLE OF CONTENTS

1 GENERALITIES.....	4
1.1 Warnings	4
1.2 Service	5
1.3 Authorized technician	6
1.4 Definitions	6
1.5 Labels	7
2 SPECIFICATIONS AND INSTALLATION	8
2.1 Overall Dimensions	8
2.2 Electrical Rating (per oven)	9
2.3 Installation	9
2.4 Connections	10
2.4.1 Electrical Plug.....	10
2.4.2 Plumbing	11
2.5 Exhaust and Ventilation	12
2.6 Type of Ventilation Installation	13
2.7 Stacking Multiple Ovens.....	14
3 SAFETY PRECAUTIONS	15
4 OPERATION.....	16
4.1 User Interface.....	16
4.1.1 Fan Speed Setting.....	17
4.1.2 Top Heat Setting	18
4.1.3 Bottom Heat Setting	19
4.1.4 Baking ON/OFF	20
4.1.5 Cooking Time	21
4.1.6 Visual Information.....	22
4.1.7 System	22
4.1.8 Recipes	22

4.2 System	23
4.2.1 User Login	25
4.2.2 Alarm	26
4.2.3 About	27
4.2.4 Monitoring	28
4.2.5 Running Stats	28
4.2.6 Date / Clock	29
4.2.7 Conveyor Chain Lubrication	30
4.2.8 Settings	31
4.3 Initial Start-up	32
4.4 Basic Troubleshooting Guide	34
4.5 Start-up and preheat mode	35
4.6 Production	36
4.7 Shutdown	36
4.8 Emergencies	37
5 MAINTENANCE.....	38
5.1 User Maintenance	38
5.1.1 Schedule	38
5.1.2 Maintenance of wire mesh entry and exit conveyors	39
5.1.3 Maintenance of stone conveyor.....	39
5.1.4 Maintenance of entry and exit conveyor crumb trays	40
5.1.5 General maintenance of the exterior	40
5.1.6 Visually inspect the oven	40
5.1.7 Maintenance of main conveyor crumb trays	40
5.1.8 Lubricate both main conveyor chains	41
5.1.9 HMI Battery Replacement	43
5.1.10 Maintenance Calendar.....	43
6 USA & Canada Sales Conditions and Limited Warranty	45
7 PIZZA RECIPES	49

CONGRATULATIONS!

YOU ARE NOW THE OWNER OF A HOT ROCKS OVEN

Thank you for choosing us and giving us a chance to do what we love.

You are part of the innovators who are revolutionizing the way pizza is baked. From managing your staff, better customer reviews, superior quality product, less waste & mistakes, increased profits, both you and your business will benefit from your leading edge.



You're on your way to Rocking Everyday Life.



Join the Hot Rocks Pizza Ovens Community on Facebook.
You'll get to share your success and passion with other Hot Rockers.

FOR SAFETY, THIS OVEN CONFORMS TO

CSA Std. 1.8-2006 (R2012)
ANSI Std. Z83.11-2006 (2012)
ANSI/NSF STD. 4-2009



NOTE :
THIS MANUAL SHOULD BE KEPT FOR FUTURE REFERENCE.
STORE IT SOMEWHERE EASILY ACCESSIBLE.

1 GENERALITIES

1.1 Warnings

DO NOT USE OR STORE GASOLINE, PRODUCTS WITH FLAMMABLE VAPORS / LIQUIDS WITHIN THE VICINITY OF THIS, OR ANY OTHER APPLIANCE.



WARNING

This symbol specifies important safety instructions which, if not followed, could endanger personal safety and/or property. Read and follow all instructions in this manual before attempting to operate the oven.

Failure to comply with these instructions may result in personal injury.

- Read, understand, and follow all instructions in this manual before starting. Keep this manual in a safe place for regular reference.
- Only allow responsible individuals familiar with the instructions to operate the oven. Be sure to know the controls and how to stop the oven quickly.
- Never put hands near moving parts.
- Only allow authorized technicians to perform the maintenance of the oven.
- Remove all obstacles which may interfere with the oven's functions.
- Clear the work area of any items such as electrical wires, buckets, knives, etc.
- Do not sit or stand on the oven.

- Always turn off the oven with the main switch or leave it on standby mode after the work is done. Never leave a running oven unattended.
- Always disconnect the electric plug and wait until the oven has cooled before attempting any maintenance.
- Do not wear loose-fitting clothes or jewellery as they may get caught in the moving parts of the oven.
- Always wear appropriate shoes to prevent injury caused by moving the oven or hot objects falling from the oven.
- Work only in daylight or with sufficient artificial light.
- Do not operate the oven while under the influence of alcohol, drugs or any illegal substance.

1.2 Service

Prior to disposal, determine the proper method to dispose of waste from the local office of the Environmental Protection Agency. Recycling centers are established to properly dispose of materials in an environmentally safe fashion.



WARNING

This oven should only be operated by staff that has read, understood and will respect warnings and instructions regarding this oven in the user manual. Save these instructions for future reference.

**DO NOT SPRAY LIQUIDS OR VAPORS ON, OR NEAR, ELECTRICAL EQUIPMENT.
DO NOT USE THIS APPLIANCE IF ANY OF ITS PARTS HAVE BEEN UNDER WATER.**

IMMEDIATELY CONTACT A QUALIFIED SERVICE TECHNICIAN TO INSPECT THE APPLIANCE AND TO REPLACE ANY PARTS WHICH WERE SPRAYED OR SUBMERGED UNDER WATER.

1.3 Authorized technician

All installations and/or service on any Hot Rocks ovens must be performed by qualified, certified, licensed and/or authorized installers and technical service personnel. All electrical, gas and plumbing connections must be made by authorized technicians and in compliance with all electrical, gas, plumbing and safety requirements.

It is possible to obtain these services by contacting Hot Rocks customer service or a local service companies. Refer to the Hot Rocks website for a list.

1.4 Definitions

USERS

A user is those who will operate the oven. There are two different levels of users; basic user and advanced user.

BASIC USER

Basic users are those who will work everyday with the oven to cook pizza. A basic user has been trained by an advanced user or an authorized technician to safely operate the oven. They can also perform daily and weekly operator maintenance.

ADVANCED USER

Advanced users are those who received the proper training from the authorized technician to perform monthly operator maintenances. They can lock cooking parameters from the basic user.

QUALIFIED AND/OR AUTHORIZED TECHNICIAN

Qualified or authorized operating personnel are those who have carefully read the information in this manual and are familiar with the oven's functions or have had previous experience operating Hot Rocks ovens.

QUALIFIED INSTALLATION PERSONNEL

Qualified installation personnel can be represented by an individual, a firm, a corporation or a company which will perform and is responsible for:

- The installation of gas piping from the outlet side of the gas meter or service regulator when the meter is not provided, and the connection and installation of the gas appliance. The qualified installation technician must be experienced in such work, familiar with all required precautions, and comply with all requirements of state or local authorities having jurisdiction. Reference in Canada: *Canadian Standard CAN/ CSA-B149.1 and Z223.1 / NFPA 54 (Natural and/or propane gas installation code)*
- The installation of electrical wiring from the electric meter, main control box or service outlet to the electric appliance. The qualified installation technician must be experienced in such work, familiar with all required precautions, and comply with all requirements of state or local authorities having jurisdiction.
- The appliance, when installed, must properly be electrically grounded in accordance with local codes, or in the absence of local codes, with the National Electrical code *ANSI/NFPA 70*, or the Canadian Electrical code, *CSA 22.1 No 109* or conform to *UL STD 197*.

1.5 Labels

**EACH HOT ROCKS OVEN HAS THE FOLLOWING LABELS (NOT TO SCALE).
THEY SHOULD NEVER BE REMOVED.**

DANGER-WARNING
Never put hands inside the oven while the conveyor is moving.

MODEL / MODÈLE:		GAS / GAZ:	
SERIAL / SÉRIE:		MAN. PRESSURE/ PRESSION D'ÉCHAP. :	
ELECTRICITY / ÉLECTRICITÉ:		LINE PRESSURE / PRESSION D'ENTRÉE :	
AMPS / AMPÈRE:		NOZZLE / ORIFICE :	
HP / CV:		INPUT / DÉBIT (BTU / H) :	



PICARD OVENS • FOUR PICARD
HOT ROCKS OVEN • FOUR HOT ROCKS

QUÉBEC, CANADA
WWW.PICARDOVENS.COM
WWW.HOTROCKSOVEN.COM

HOT ROCKS OVEN (GAS) / FOUR HOT ROCKS (GAZ)

CLEARANCES TO COMBUSTIBLES / DÉGAGEMENTS AUX COMBUSTIBLES

COMBUSTIBLE AND NON-COMBUSTIBLE MATERIAL	MATÉRIEL COMBUSTIBLE ET NON-COMBUSTIBLE
2"	2"

- INTENDED FOR OTHER THAN HOUSEHOLD USE.
- FOR INSTALLATION UNDER A VENTILATION HOOD ONLY.
- SUITABLE FOR INSTALLATION ON COMBUSTIBLE FLOOR.

- POUR UTILISATION AUTRE QUE DOMESTIQUE.
- POUR INSTALLATION SOUS UNE HOTTE DE VENTILATION SEULEMENT.
- PEUT ÊTRE INSTALLÉ SUR UN PLANCHER COMBUSTIBLE.

CERTIFIED TO / CERTIFIÉ À
CSA Std. 1.8-2006(R2012)

CONFORM TO / CONFORME À
ANSI Std. Z83. 11-2006(R2012)
ANSI/NSF Std. 4-2016

Intertek
9700551

GAS FOOD SERVICE EQUIPMENT
ÉQUIPEMENT DE RESTAURATION À GAZ

Intertek

MADE IN CANADA / FAIT AU CANADA 1053-0103 REV 01

WARNING

**DISCONNECT POWER
SUPPLY BEFORE SERVICING
AND MAINTENANCE.**

AVERTISSEMENT

**COUPER L'ALIMENTATION AVANT
L'ENTRETIEN ET LE DÉPANNAGE.**

IMPORTANT

COOK ONLY PIZZAS AND / OR BREADS DIRECTLY UPON THE BAKING STONE.
ALWAYS COOK ALL OTHER FOODSTUFF IN PROPER COOKING RECEPTACLES.

CUIRE SEULEMENT LES PIZZAS OU LES PAINS DIRECTEMENT SUR LA SOLE.
TOUTES AUTRES NOURRITURES DOIVENT ÊTRE CUITES DANS UN RÉCIPENT APPROPRIÉ

2 SPECIFICATIONS AND INSTALLATION

2.1 Overall Dimensions

	HR-70-22		HR-70-33		HR-93-33	
BAKING SURFACE	70"	178 cm	70"	178 cm	93"	236 cm
CONVEYOR WIDTH	22"	56 cm	33"	84 cm	33"	84 cm
FULL LENGTH	123 ½"	314 cm	123 ½"	314 cm	146 ½"	372 cm
WIDTH	50 ½"	128 cm	61 ½"	156 cm	61 ½"	156 cm

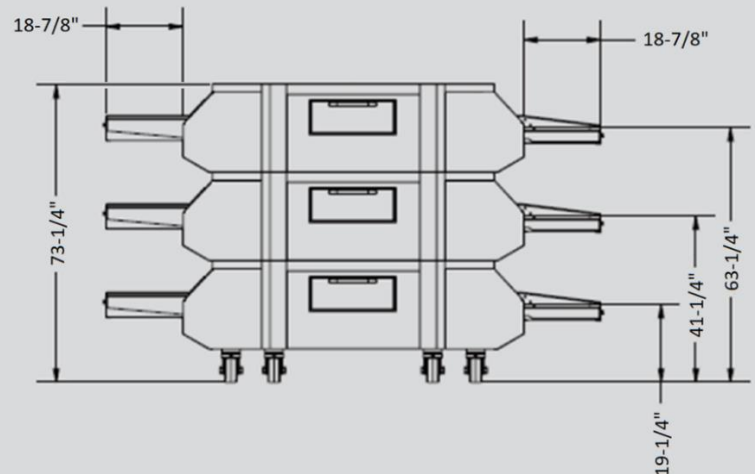
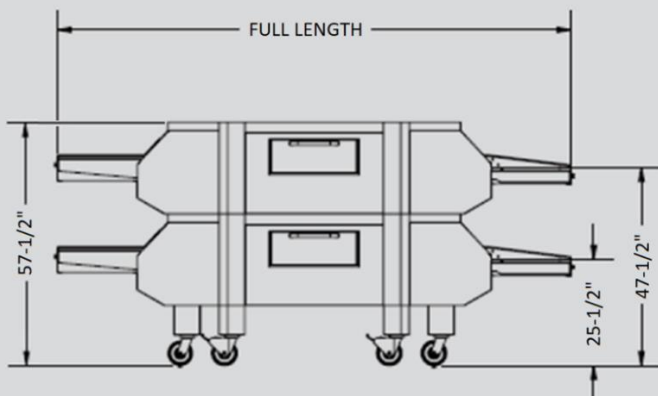
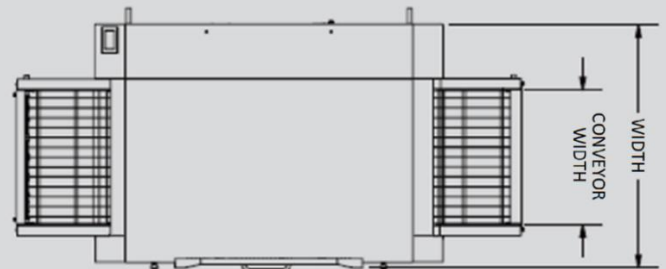
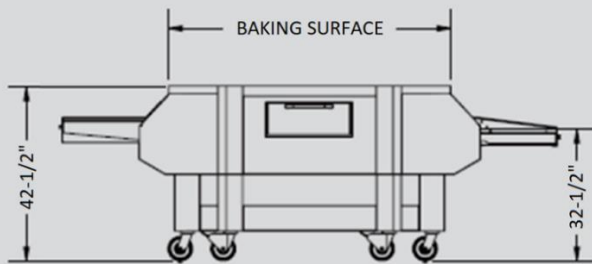

* When stacking multiple ovens, a high temperature silicone must be applied between each unit to ensure a proper seal. Refer to section 2.7.

2.2 Electrical Rating (per oven)

Electrical Rating (per deck)

	Voltage	Amps	Volt-Ampere	Phase	Hertz	Cabling
All Models	208-240V	10A	2400V-A maximum	1PH	60Hz	3 wires cord



WARNING
Improper installation, adjustments, alteration, servicing or maintenance could result in property damage, injury or even death.

2.3 Installation

Prior to the installation, make sure that:

- Entrance of the building all the way to the desired location respects the overall dimensions of the oven model. See section 2.1 for measurements.
- The oven will not be enclosed, and there is a proper venting hood.
- The connections required to start the oven are already installed and verified to be working.
- A minimum of 6 inches of clearance all around the oven.

Refer to the Hot Rocks specification sheet for the installation requirements.

For additional details, refer to the following documents:

- Hot Rocks - Specification Sheet
- Hot Rocks - Technician's Manual

These documents are available on the Hot Rocks website.

2.4 Connections

Back view of the oven

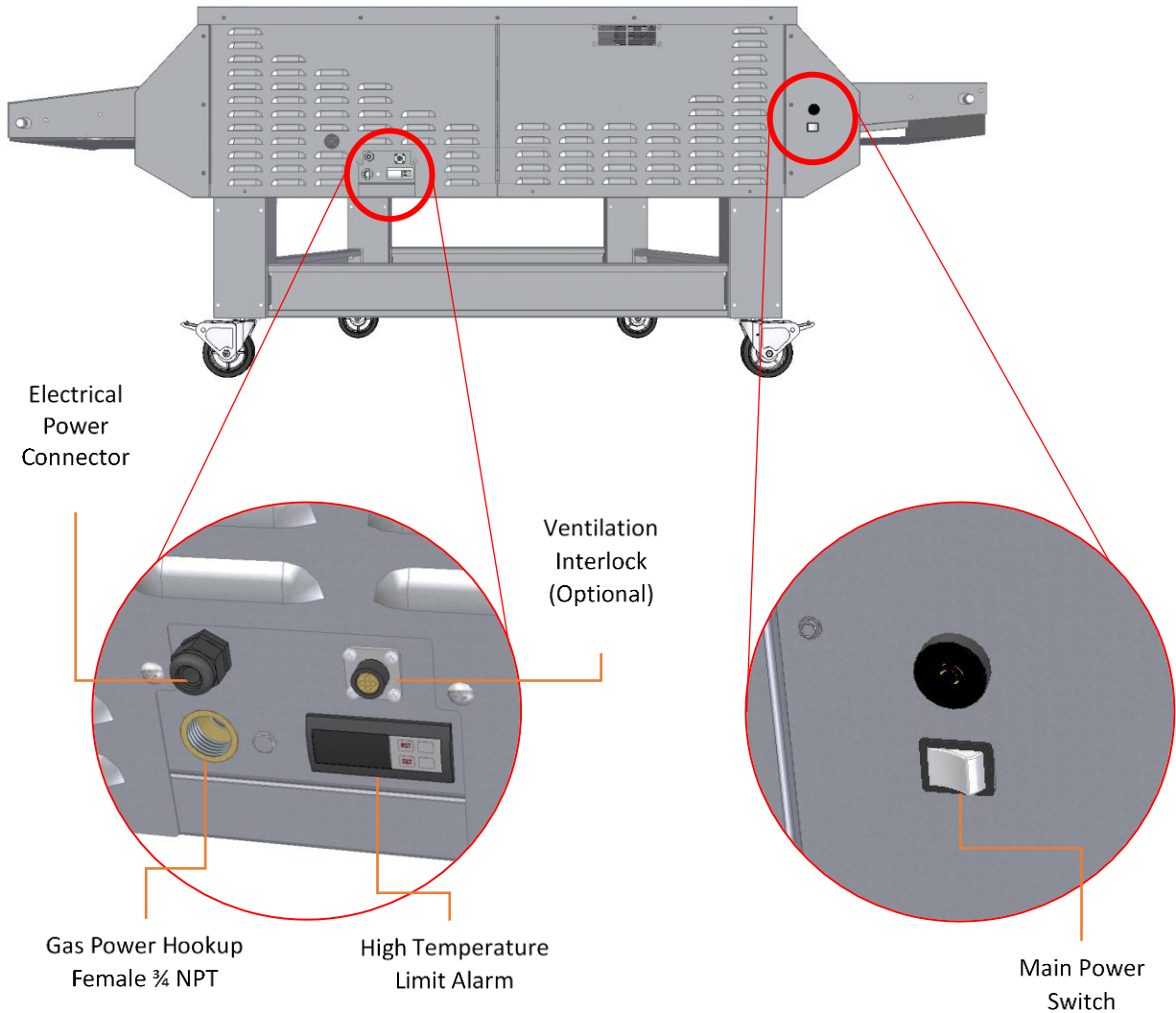

2.4.1 Electrical Plug

The Hot Rocks oven requires a dedicated electrical inlet to the following specifications: .208-240V/1PH/60Hz-10A. The oven comes with 5 feet power cord and 15A 250VAC plug type NEMA 6-15R. The plug can be fitted with an adaptor or changed by an electrician following the electrical requirement in accordance with the local codes.



2.4.2 Plumbing



WARNING

Always turn off the main power switch before plugging or unplugging the oven. See section 2.4 for location of the switch.

The Hot Rocks oven requires a gas inlet of either natural or propane gas, depending on the model purchased. It is mandatory to install a gas valve to safely shutoff gas to the appliance. It is highly recommended to install a quarter turn gas valve and a “quick connect” plug for ease of maintenance. The connection must be done by a qualified technician who has proper certification in the area and in accordance with local codes.



***Note that the gas hose does not come with the unit. The customer must purchase one and have it available on site for the installation day.**



WARNING

Always turn off the gas when plugging or unplugging the oven.



WARNING

The gas pressure must be adjusted between 6” and 8” W.C. or 15 mBar to 20 mBar for internationals.

GAS ENTRY CONNECTION

The Hot Rocks oven is on casters and must be connected to the gas line by flexible tubing. A safety chain must retain the Hot Rocks oven to the wall to prevent it from moving.

The length of the safety chain must stop the flexible hose from completely straightening.

2.5 Exhaust and Ventilation

A Hot Rocks oven requires a ventilation hood to operate correctly and safely.



WARNING

The areas surrounding the unit should be kept clear to allow necessary air flow, which is required for proper combustion and operation. Unit should also be positioned for easy maintenance access.



WARNING

According to local code, this oven could be interlocked with the venting hood. Contact Hot Rocks customer service for document 7-0025-EA VENTILATION INTERLOCK FOR GAS OVENS.



WARNING

All exhaust systems are required to have an air make-up system that replaces 100% of the exhausted air. Windows, doors, and other openings into the establishment cannot be used for the purposes of providing air make-up. A separate duct providing air into the building is required.

Do not have fans blowing directly onto the oven and wherever possible avoid opening windows next to the oven sides, or using wall type fans. Draft passing directly through the oven could cause severe inconsistencies and cooking problems.



WARNING

This oven is to be installed in an area with adequate air supply and clearance for air openings into the combustion chamber of the unit.

2.6 Type of Ventilation Installation

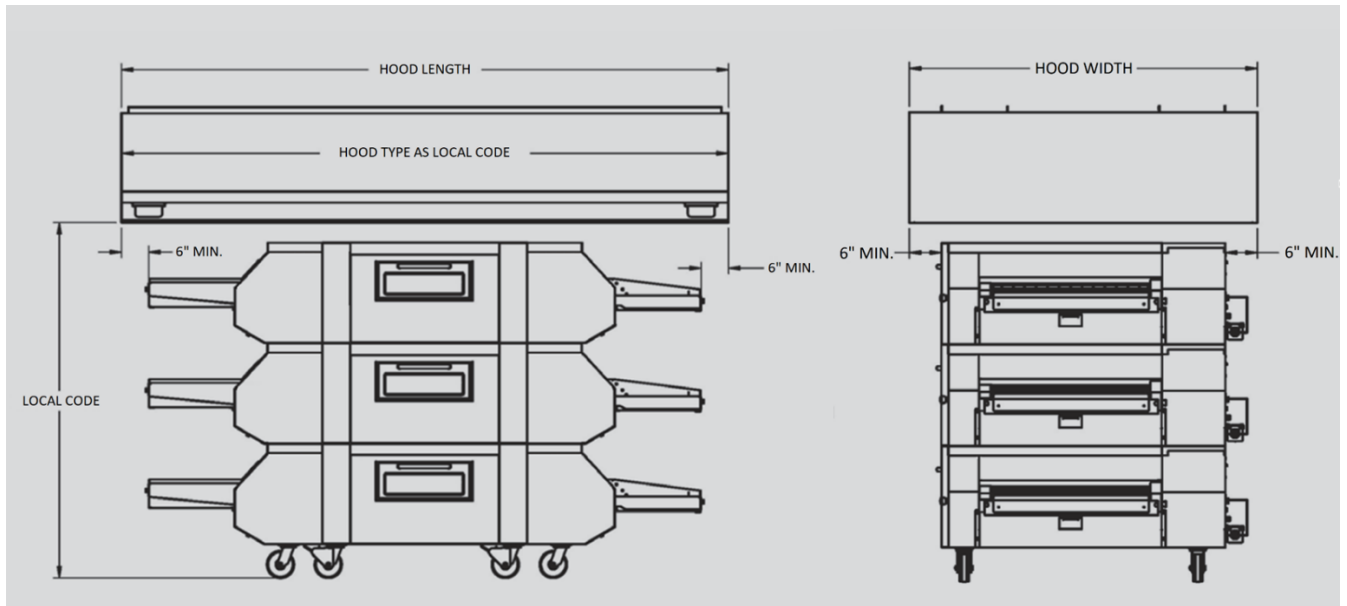

***Verify local regulations for hood specifications.**

****The drawing above is used as an example to illustrate how the oven is to be properly vented. Actual installs may look different, but must respect the minimum values.**



WARNING

This oven generates a lot of heat and must never be enclosed.

2.7 Stacking Multiple Ovens

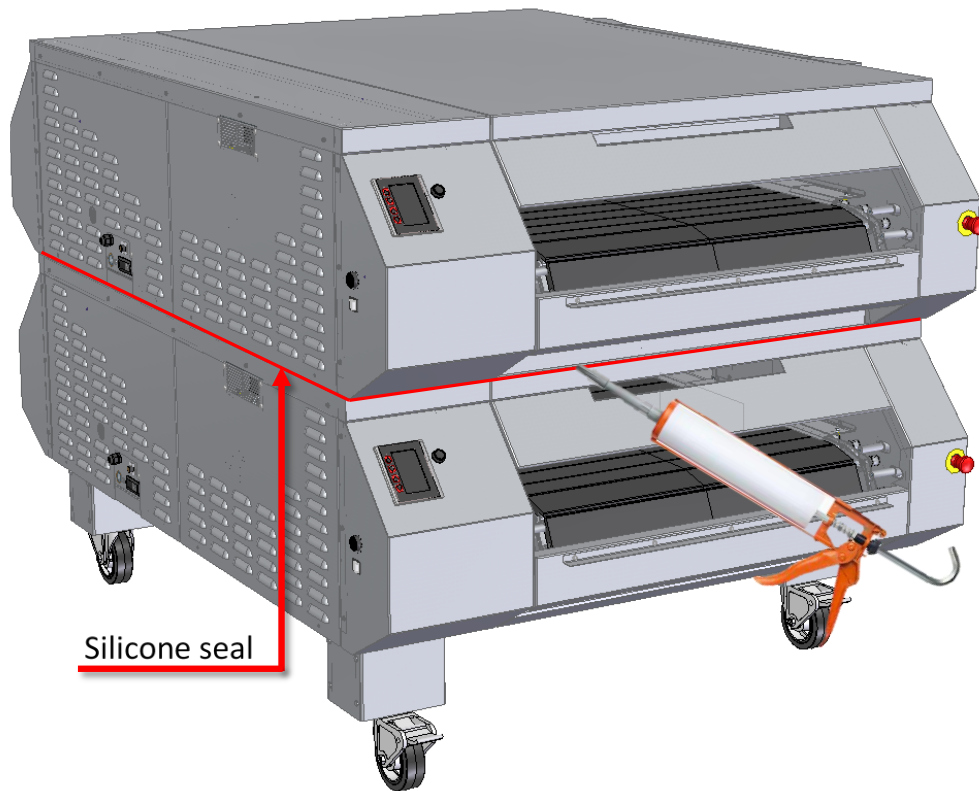

When stacking multiple ovens, a high temperature silicone must be applied between each unit to ensure a proper seal (shown in red). The seal must go all the way around the ovens with no gaps.



WARNING

Make sure that the silicone seal is smooth with no bubbles; it must not allow food particles in between units.

3 SAFETY PRECAUTIONS

FOR SAFETY READ BEFORE OPERATING



WARNING

Failure to follow these instructions could result in a fire or explosion that may cause property damage, personal injury or death.

This appliance does not have a pilot. It is equipped with an ignition device which automatically lights the burner. **DO NOT LIGHT THE BURNER MANUALLY.**

Before operating, smell around the oven for gas. Be sure to smell close to the floor as some gases are heavier than air and will settle on the floor.

What to do if there is a smell of gas

- 1 Immediately close the main manual gas valve.
- 2 Do not turn on any appliances.
- 3 Do not touch any electric switch.
- 4 Immediately contact the gas supplier using a neighbor's phone. Do not use any phones in the building
- 5 Follow the gas supplier's instructions.
- 6 If it is not possible to reach the gas supplier, contact the fire department.

*** Note that to restart the oven, wait 5 minutes in order to clear out any remaining gas in the oven.**

4 OPERATION

4.1 User Interface

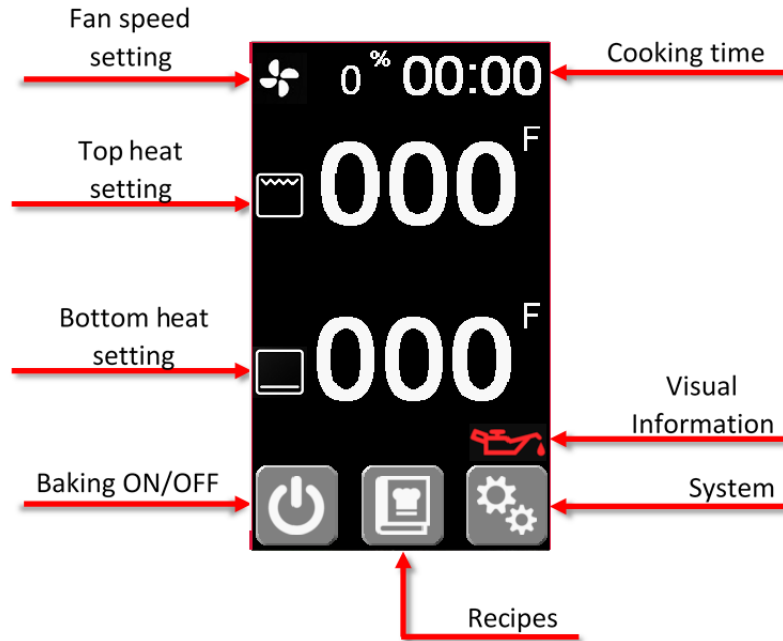

***Note that this is referred as the “main screen”**

4.1.1 Fan Speed Setting

Pressing the fan percentage opens the “FAN SPEED” page.

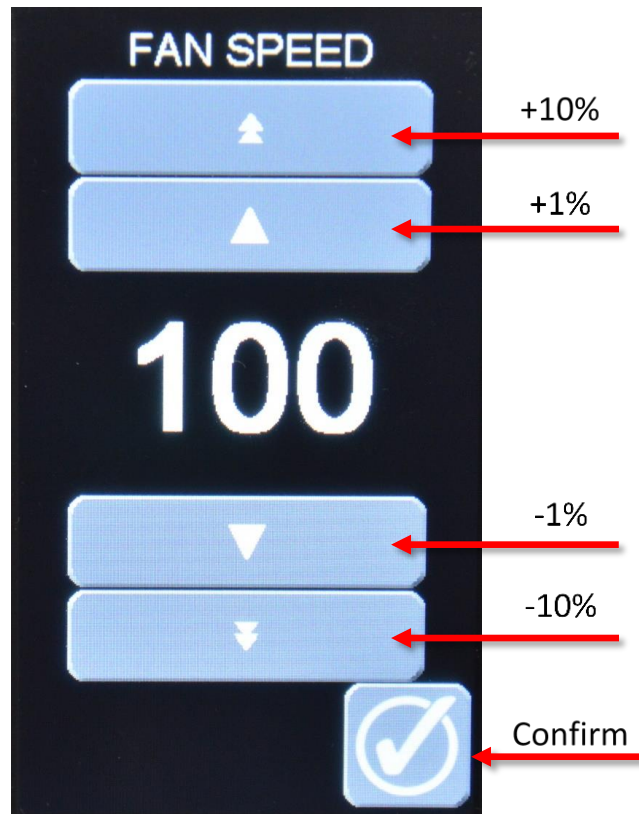

Pressing the single large arrow will increase or decrease the fan speed by 1%. Pressing the double arrows, will increase or decrease by 10%.

Touch the confirm button to return to the main screen. The fan speed is adjustable from 20% to 100%.

*** Note that this page can be password protected by the advanced user. See section 4.2 for options.**

4.1.2 Top Heat Setting

Pressing the top temperature display opens the “TOP HEAT” page.

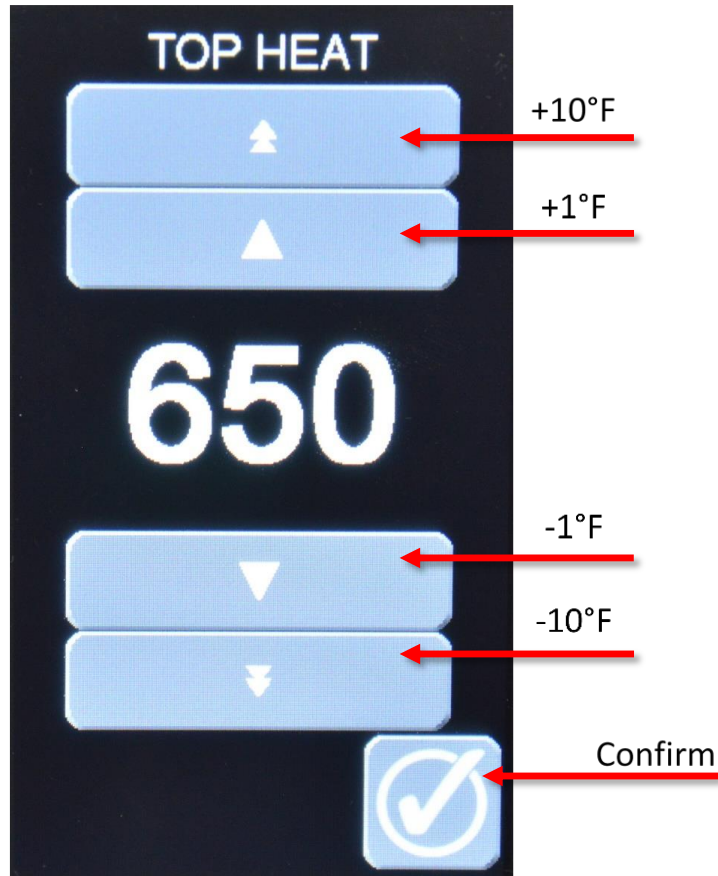

Pressing the single large arrow will increase or decrease the top heat by 1°F. Pressing the double arrows, will increase or decrease by 10°F.

Touch the confirm button to return to the main screen. The selected value will automatically be applied. The top heat is adjustable between 0 and 750°F. The top temperature must be higher up to a maximum of 150°F (65°C) more than the bottom temperature. For more stability and an even product, we recommend setting the top temperature between 60°F (15°C) and 150°F (85°C) higher than the bottom temperature.

*** Note that this page can be password protected by the advanced user. See section 4.2 for options.**

4.1.3 Bottom Heat Setting

Pressing the bottom temperature display opens the “BOTTOM HEAT” page.

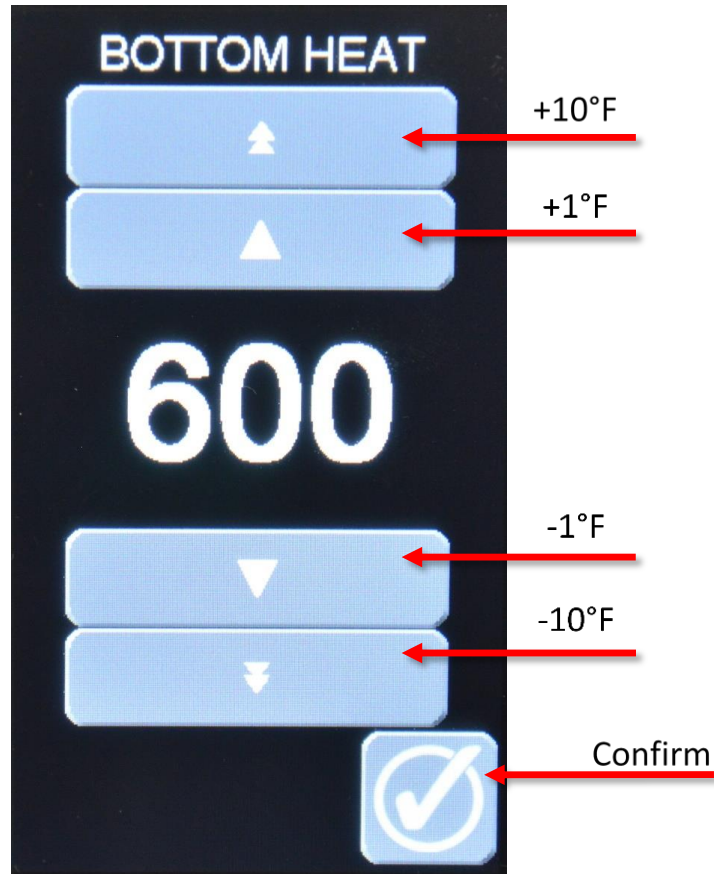

Pressing the single large arrow will increase or decrease the bottom heat by 1°F. Pressing the double arrows, will increase or decrease by 10°F.

Touch the confirm button to return to the main screen. The selected value will automatically be applied. The bottom heat is adjustable between 0 and 600°F.

*** Note that this page can be password protected by the advanced user. See section 4.2 for options.**

4.1.4 Baking ON/OFF

The Baking ON/OFF button starts and stops the oven. When the button is green, the oven is running. When the button is grey, the oven is in standby mode. Use the standby mode overnight to let the electrical panel cool down. The oven can be completely shut off with the main power switch in the back of the oven. See section 2.4 for button location.

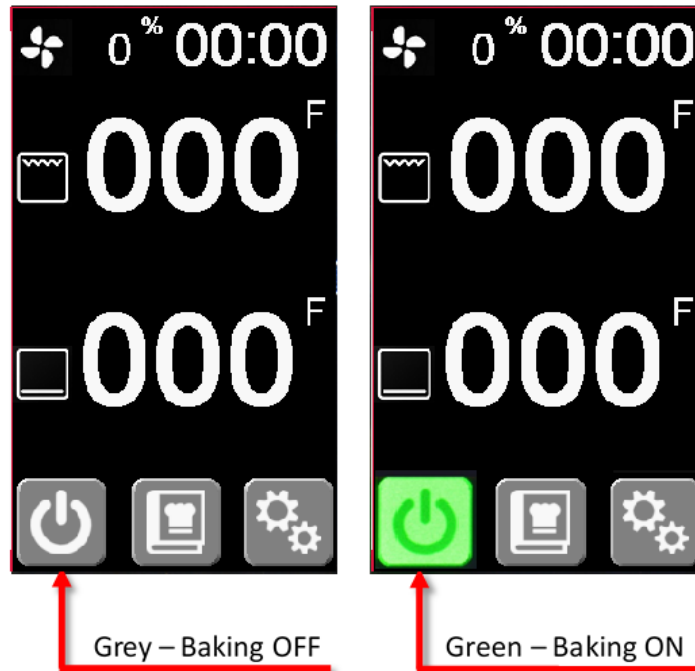

4.1.5 Cooking Time

Pressing the cooking time opens the “CONVEYOR SPEED” menu the cooking time.

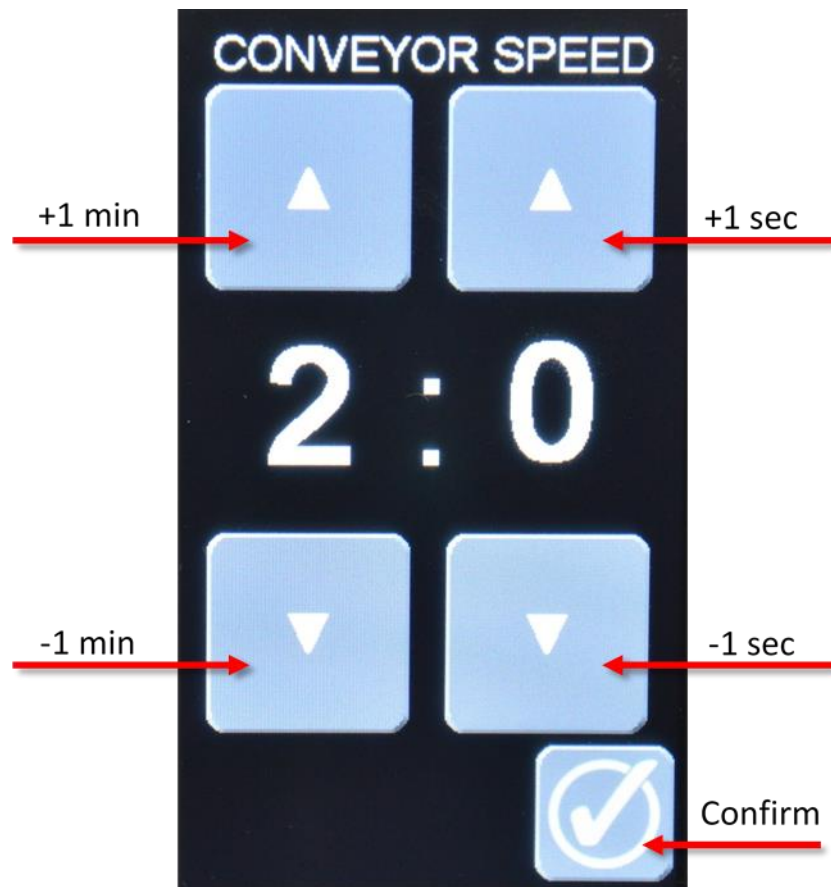



Adjust the cooking time by using the arrows. The left number shows minutes and the right number seconds. All arrows increase or decrease the number by increments of one unit.

Touch the confirm button to return to the main screen. The cooking time runs between 2 to 30 minutes.

*** Note that this page can be password protected by the advanced user. See section 4.2 for options.**

4.1.6 Visual Information

This section provides important information about the state of the oven.

Icon Displayed	Description
	Icon shown during the standby mode to cooldown the oven rapidly. Once the bottom temperature cools under 250°F for 5 minutes, the icon will disappear.
	Icon shown when the lubrication of the main conveyor chains is due. Once the lubrication is done, the icon will disappear.

4.1.7 System



Opens the “SYSTEM” menu of the oven. Referred to section 4.2 for details.

4.1.8 Recipes



Opens the “RECIPES” menu. This menu allows the user to select a pre-programmed recipe or allows the user to save a new recipe.

RECIPES		
1	CONVECT. (%)	100
	MINUTES	5
	SECONDS	30
	TOPPINGS	620
	CRUST	450
2	CONVECT. (%)	0
	MINUTES	0
	SECONDS	0
	TOPPINGS	0
	CRUST	0
3	CONVECT. (%)	0
	MINUTES	0
	SECONDS	0
	TOPPINGS	0
	CRUST	0
4	CONVECT. (%)	0
	MINUTES	0
	SECONDS	0
	TOPPINGS	0
	CRUST	0



It is possible to save up to four recipes. Selecting a recipe button applies the shown values to the actual settings. Holding the recipe button for 5 seconds will save the current setting values of the main screen to the memory of that recipe.

4.2 System



The system button opens the “SYSTEM” menu of the oven. Depending on the authorization level, some icons will not be shown.

Users have 2 authorization levels. For the basic user, the system page shows the icons on left picture. For the advanced user, the system page shows the icons on the right picture. See next section to know how to access the advanced user.

Basic User

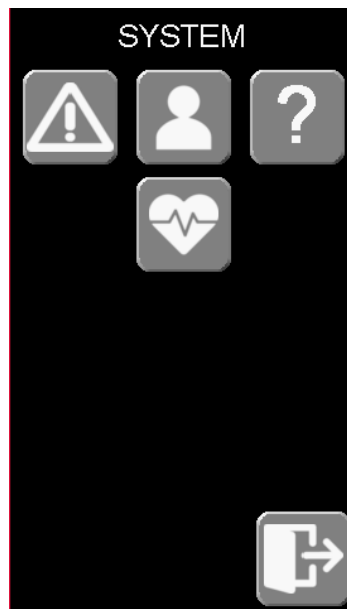

Advanced User

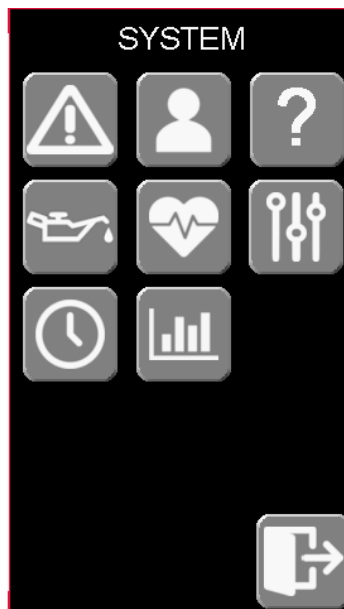

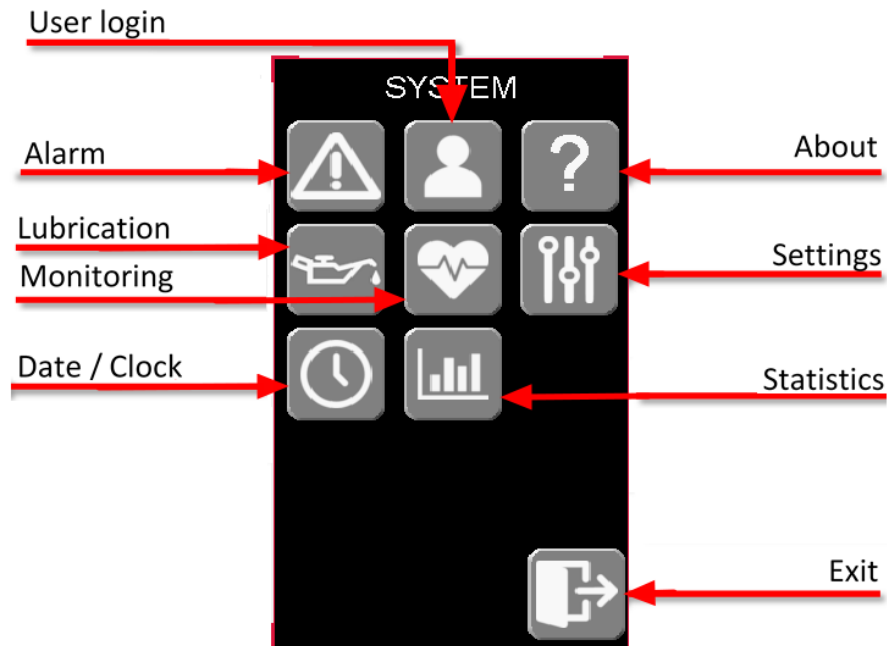

Labels of all available sections. (access is limited by user)

Default settings do not allow the basic user to modify any of the oven's parameters. It is possible to automatically enable the advanced user's authorizations when the oven is powered on. See section 4.2.7 on how to set authorizations.

Permissions	Basic User	Advanced User
Set All Cooking parameters	X*	X
Load Recipe	X	X
Save Recipe		X
Alarm page	X	X
User Login page	X	X
Statistics page		X
About page	X	X
Monitoring page	X	X
Lubrication page		X
Setting page		X
Date & Clock page		X

* Authorizations can be granted by the Advanced User. See section 4.2.7 for more information.

4.2.1 User Login



Pressing the user login button opens the “USER” menu.

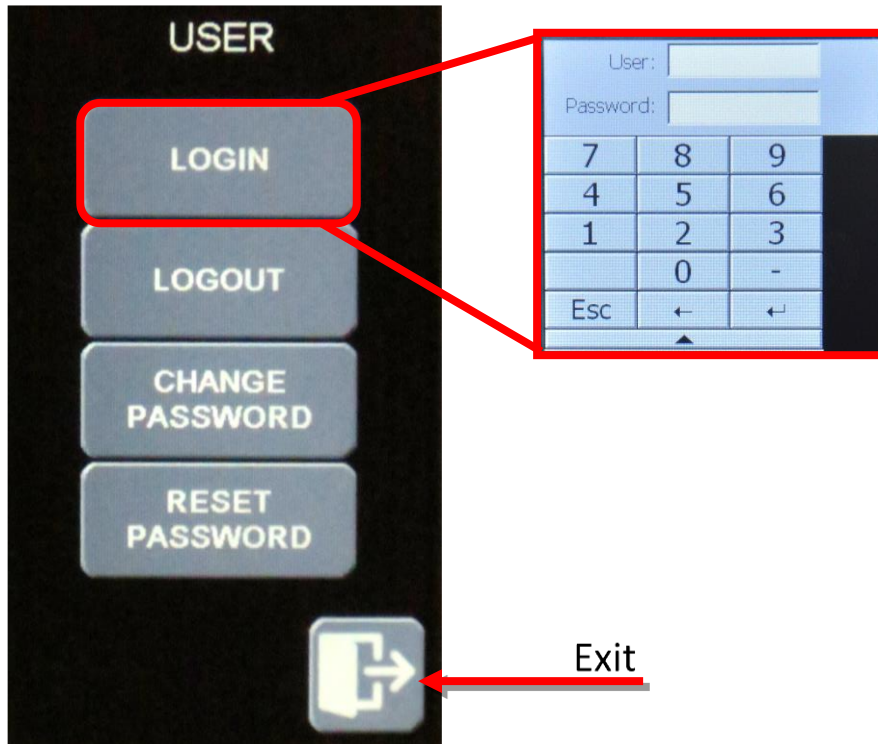

By default, the basic user is logged in unless the advanced user had already granted additional authorization. See section 4.2.3. The basic user will never need to log in. When the advanced user logs out, the system will automatically swap to the basic user.

Advanced users can login using the following credentials:

User: 1
Password: 1234

This menu also allows an advanced user to change their password or reset it. The advanced user can also log out to be sure that their settings cannot be changed.

After 15 minutes without touching the screen, the advanced user will be automatically logged out.

4.2.2 Alarm



The alarm button opens the “ALARMS LOG”. In this page, the last 100 alarms are recorded.

If alarms are still active, a button will appear on the top right corner of the screen allowing them to be reset. If the alarm remains, escalate the problem. The double arrows button allows to scroll through the log.

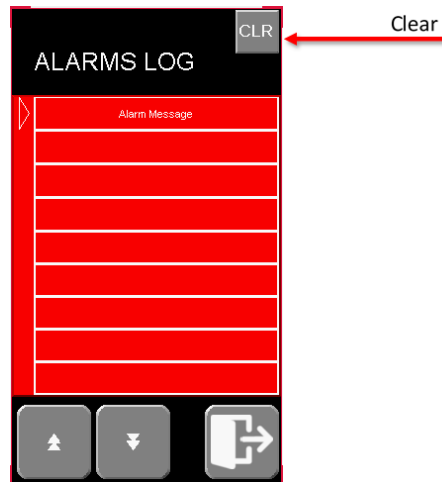

Alarms appear on the main screen of the oven as shown below.

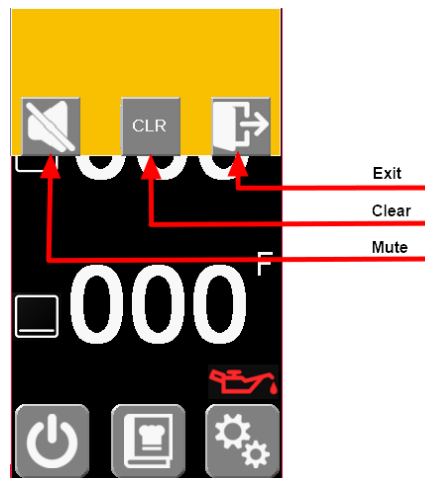

Mute: Stops the sound of the alarm but the messages will remain.

Clear: Resets the alarm. If the problem is not solved, the alarm will reappear.

Exit: Erases the alarm message without clearing the alarm and without stopping the sound of the alarm. A new icon will appear for any user under the system menu allowing them to silence the alarm.

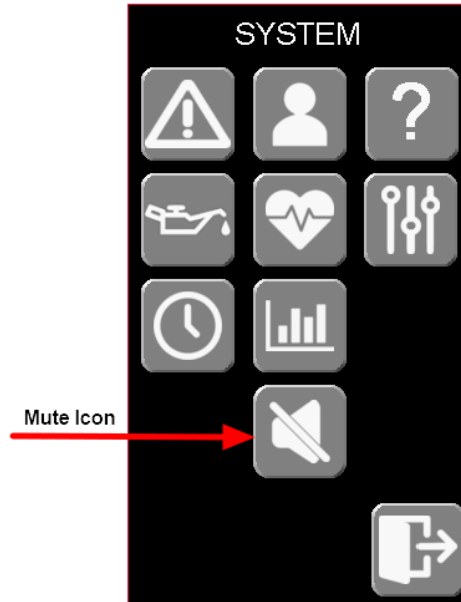

4.2.3 About



Shows Hot Rocks contact information and software version.



4.2.4 Monitoring



Allows the user to view the parameter of the oven in real time. This page is essential for diagnostics.

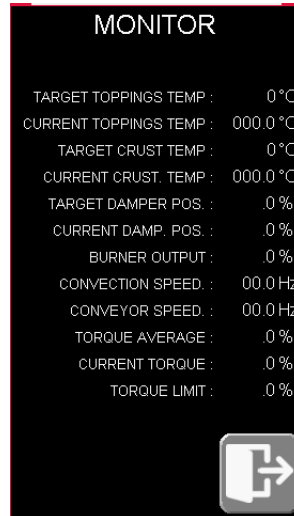

4.2.5 Running Stats



Shows the performance of the oven to reach each temperature step. The first row shows the time required for the oven to raise the bottom temperature from 100°F to 200°F. This information is refreshed on every time the oven passing by these temperatures continuously without an interruption.

*** Note that this is an example and will not be the exact details for every oven.**

RUNNING STATS	
FROM 38°C TO 93°C	
TIME MINUTE	RECORD DATE
0	0
FROM 93°C TO 149°C	
TIME MINUTE	RECORD DATE
0	0
FROM 149°C TO 204°C	
TIME MINUTE	RECORD DATE
0	0
FROM 204°C TO 260°C	
TIME MINUTE	RECORD DATE
0	0
FROM 260°C TO 316°C	
TIME MINUTE	RECORD DATE
0	0

4.2.6 Date / Clock



The “CLOCK” page allows the advanced user to change the date and the time.

A screenshot of a dark-themed user interface titled "CLOCK". It features seven input fields for date and time settings, each with a label on the left and a value in a white-bordered box on the right. The settings are: YEAR (2020), MONTH (10), DAY (16), HOUR (13), MINUTE (14), and SECOND (24). At the bottom right of the form is a blue square button with a white icon of a door and an arrow pointing right.

CLOCK	
YEAR	2020
MONTH	10
DAY	16
HOUR	13
MINUTE	14
SECOND	24

* Note that the oven works with 24 hour time.

4.2.7 Conveyor Chain Lubrication



The “LUBRICATION” menu allows the user to easily monitor and perform the lubrication of the oven. The advanced user can see how many days are left before the next lubrication. A reminder will appear on the main screen when the lubrication is due.

The lubrication of the stone conveyor chain every 30 days is an essential part of the maintenance to keep the oven working optimally. It also extends the lifespan of the oven.



WARNING

**Always perform this maintenance while the oven is cool.
Do not forget to start the hood ventilation in the kitchen.**

Pressing the “Start Lubrication” button, will temporarily change settings of the oven to optimize lubrication. For optimal result perform this maintenance while the bottom temperature of oven is around 200°F. See section 5.1.8 for details on how to perform the lubrication. When the lubrication is due, an alarm will pop-up on the main screen every time the oven is started.

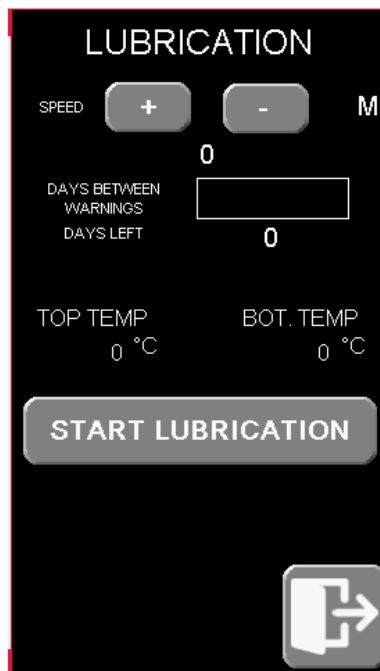

4.2.8 Settings



The "SETTINGS" page allows the advanced user to set language, temperature units and the authorizations for the basic user.

The languages available are English, French and Spanish.

The temperature units are Celsius or Fahrenheit

Selecting YES for the "ALLOW COOKING PARAMETERS CHANGE WITHOUT LOGIN" will automatically log in the advanced user when the oven is powered up. This will allow the basics user to change cooking time, temperature and fan speed.

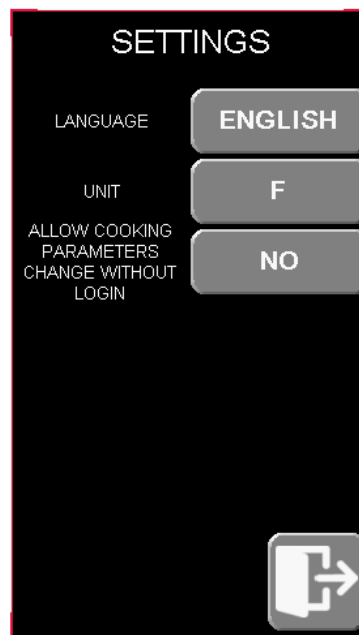

4.3 Initial Start-up

The following procedure is only for the initial start up and must to be done with the assistance of a qualified technician. It could be performed by the technician on site during the installation, a Hot Rocks sales representative or by Hot Rocks customer service technician.

The user must fully understand how to lubricate the chains by themselves and how to perform all other user maintenances.



WARNING

Never put hands in the oven at any time while it is running.

- 1- Make sure that electric and gas connections are connected and that nothing is in the way of the conveyors or inside the tunnel. Once everything is verified, turn on the oven using the main power switch on the back of the oven. See section 2.4 for location.
- 2- Verify that the language and temperature are set properly for the user.
- 3- Explain to any users how the main screen works and refer them to the operation section of this manual for complete details.
- 4- Make sure the physical emergency stop buttons are not engaged and start the oven by pressing the Baking ON/OFF button on the main screen. Test both emergency buttons to verify they work.
- 5- Let the oven run for 10 minutes, during that time visually inspect moving parts and pay attention to any suspicious noises. The graphite bushings are likely to emit a small but tolerable noise.
- 6- After 10 minutes, perform the lubrication of the stone conveyor chains. See section 5.1.8.
- 7- Show users how to clean the stones with a scraper. Do not use liquid.
- 8- Explain to the users how to perform daily/weekly maintenance.

9- Confirm with the user that they understand whom to call in case of emergency see section 4.8 Emergencies. Be sure to have the following information before calling;

- Serial number
- Model number
- Problem information and error code if applicable
- Oven location (restaurant address)
- If the oven is functional or not

10- Confirm with the user that they understand how to start, operate, shut-down and maintain the oven. Leave the maintenance schedule with the oven.

11- Ready to cook.

4.4 Basic Troubleshooting Guide

	PROBLEMS	CAUSES	SOLUTIONS
	THE HOT ROCKS OVEN WON'T START	There is an electricity issue.	Make sure the oven is plugged in. Make sure the breakers of the electrical panel are not tripped.
	THE MAIN CONVEYOR IS MOVING IN THE WRONG DIRECTION.	The oven parameter is not setup properly.	Contact the Hot Rocks Service line.
	THE ENTRY/EXIT CONVEYORS ARE NOT MOVING.	The handle is not engaged.	Push the handle in place. See section 5.1.2 for details.
Hot Rocks alarm	IGNITION FAILURE	There is no gas. Flame rod are misadjusted.	Make sure the gas valve is open.
	PRESSURE SWITCH SIGNAL LOST	The oven is not receiving the confirmation that the hood is working.	Verify that the hood is working. Contact a service company.
	CONVEYOR STUCK	Something has blocked the stone conveyor mechanism.	Verify if there are debris that blocking the conveyor movement.
	EMERGENCY STOP ENGAGED	The emergency stop button(s) have been pushed.	Inform the manager to make sure the oven can be restarted safely. Released the emergency stop button(s) by twisting them.
	HIGH TEMPERATURE LIMIT	The bottom temperature reached 800°F. The oven will automatically start the cold down process.	Do not use the oven. Contact a service company.
	DAMPER STUCK	The damper that controls the top temperature is stuck.	Do not use the oven. Contact a service company.
	FV1 ALARM: Alarm message	The FV1 drive that controls the stone conveyor motor has an issue.	Read the message and contact a service company.
	FV2 ALARM: Alarm message	The FV2 drive that controls the convection fan motor has an issue.	Read the message and contact a service company.
	TORQUE TOO HIGH	The stone conveyor has difficulty to move.	Lubricate the main conveyor chains. Contact a service company.
	OVEN NEEDS LUBRICATION	The oven is due to lubricate every month.	Lubricate the main conveyor chains.

***If the oven is covered by the Hot Rocks warranty, contact Hot Rocks customer service instead of a service company.**

4.5 Start-up and preheat mode

The following procedure is the recommended usage for any normal production day. It should be done by a knowledgeable and properly trained user.

1. Perform the daily maintenance.
2. Select the recipe or set the desired settings then press the “Baking ON/OFF” button.
3. If the temperature is below the preheat temperature setting (default preheat temperature is below 250°F) the oven will start in preheat mode. The percentage of preheat is showed 0, 10, 25, 50, 75, 90%. **The preheat normally stay at 90% longer to ensure the temperature are stable.**
4. Once the temperature inside the oven has reached the required temperature and stabilize, the temperatures on the main screen will turn **green**.

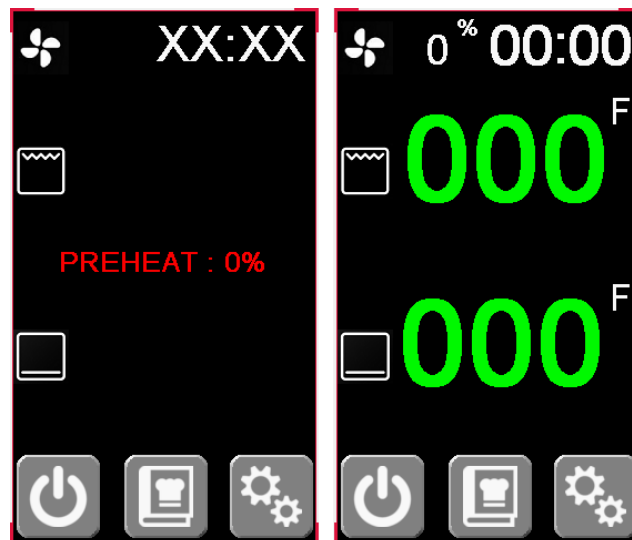

4.6 Production



WARNING

Never put hands in the oven at any time while it is running.



WARNING

Sudden temperature change in the stones may cause them to crack. Avoid putting ice directly on hot stone.

- Place the food on the entry conveyor and collect it on the exit conveyor. Never collect the product inside the oven with hands; use a proper tool for that purpose.
- To save energy, reduce the top temperature and the ventilation speed when the oven is not being used.

4.7 Shutdown

1. Press the “Baking ON/OFF” button on the user interface. The cooling mode icon (snow flake) will appear as shown;

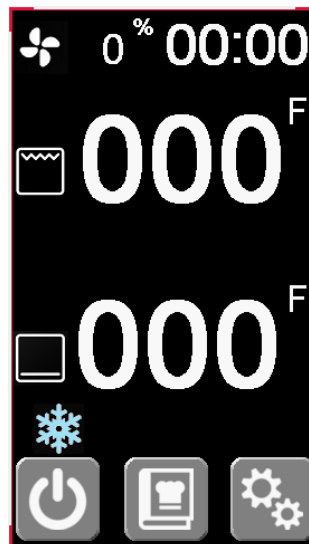

2. Let the oven cool down until the snow flake disappears from the main screen.
3. Turn off the main power switch on the back of the oven. See section 2.4 for location.

4.8 Emergencies









In case of emergency during the production:

- 1- Press one of the emergency buttons and address the problem if it is minor.
- 2- Call local service company if the problem cannot be identified or if assistance is required. The service company will call the Hot Rocks Service Department 1 800 668-1883 if needed.
- 3- If the oven is covered by a Hot Rocks warranty, contact Hot Rocks customer service for assistance 1 800 668 1883.
- 4- If there is a security risk rely to gas leak or fire hazard, contact the gas supplier first or the fire department following the procedure section 3.

5 MAINTENANCE

5.1 User Maintenance

5.1.1 Schedule

<p><u>DAILY</u></p> <p> Clean wire mesh of entry and exit conveyors</p> <p> Maintain stone conveyor with scraper</p> <p> Clean entry and exit conveyor crumb trays</p> <p> Keep the oven clean</p> <p> Visually inspect the oven</p>	<p><u>WEEKLY</u></p> <p> Clean both main conveyor crumb trays</p>
	<p><u>MONTHLY</u></p> <p> Lubricate both main conveyor chains with lubricant F075 0050 found in semi-annual maintenance kit T00000610</p>
	<p><u>EVERY 6 MONTHS</u></p> <p> Contact your local service company for maintenance and have kit T00000610 on hand</p>
	<p><u>EVERY 12 MONTHS</u></p> <p> Contact your local service company for maintenance and have kit T00000611 on hand</p>



WARNING

Depending on baking temperature, daily operating hours and conveyor speed, chain lubrication may be required every 2 weeks or more often.

The Hot Rocks oven requires regular maintenance to prevent premature failure. The following pages show the maintenance requirements of the oven for optimal operation. It is the user's responsibility to ensure the maintenance is performed as required. It is also up to the user to schedule the maintenance that require a qualified technician.

For more information on the maintenance that need to be performed by a certified technician, refer to document "Hot Rocks - Technician Manual". This manual is available on the Hot Rocks website.

*** Note that the qualified technician is not responsible to perform the user's maintenances**

5.1.2 Maintenance of wire mesh entry and exit conveyors

1. Turn OFF the main power switch on the back of the oven.
2. Remove the crumb tray.
3. Be sure the mesh is cold. Place your hand on the mesh to move it forward and backward by pulling the handle to remove the wire belt.
4. Pull the wire belt up.
5. Clean the wire belt with a cloth and warm water.

Removing wire mesh conveyor

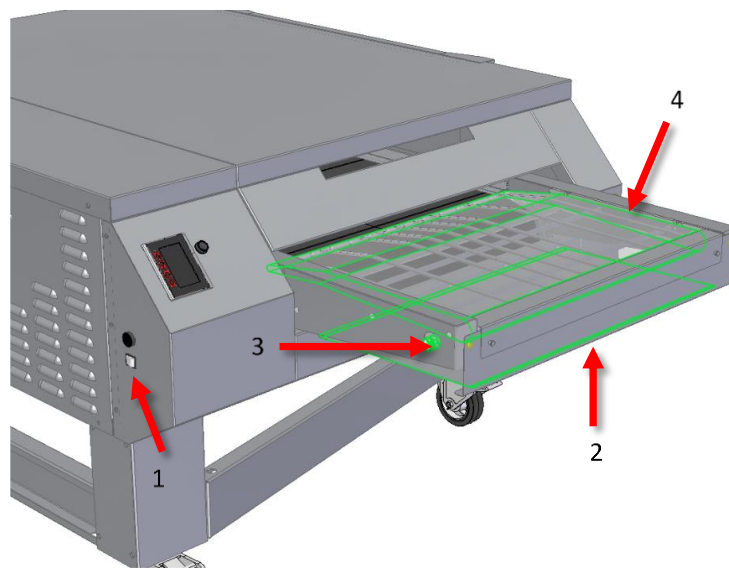

5.1.3 Maintenance of stone conveyor



WARNING
Do NOT clean a hot stone with liquids or it could crack.

1. Remove the cover.

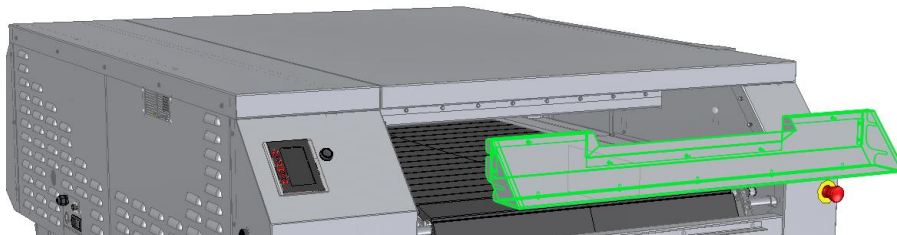

2. Press “Baking ON/OFF” to start the stone conveyor rolling and adjust the baking time to 2 minutes.
3. Clean the stones with a metal scraper and wipe the stones with a clean dry cloth.

5.1.4 Maintenance of entry and exit conveyor crumb trays

1. Remove the crumb tray under the entry and exit conveyors by sliding them out towards the entry/exit of the oven.
2. Wipe crumbs into a garbage bin with a dry cloth.

5.1.5 General maintenance of the exterior

1. Wipe all surfaces with a clean dry cloth.
2. Cleaning liquids to shine stainless steel can be used on the external stainless steel parts of the oven.

5.1.6 Visually inspect the oven

1. Look around the oven for broken or worn parts.
2. If any unusual findings are discovered call your service technician or the Hot Rocks service line if the oven is under warranty.

5.1.7 Maintenance of main conveyor crumb trays

1. Turn OFF main power switch in the back of the oven. See section 2.4 for location.
2. Remove the crumb tray by pulling forward.
3. Vacuum/clean the crumb drawer and put it back in place. Use a wet cloth to clean the crumb tray if there are stuck particles.
4. Repeat previous steps on other side of the oven.

Removing stone conveyor crumb trays

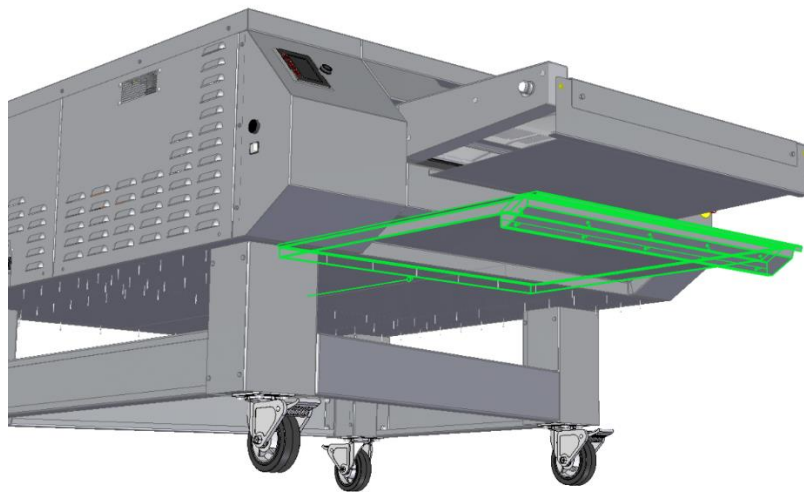

5.1.8 Lubricate both main conveyor chains



1. Go to the “LUBRICATION” setup page and start the lubrication. The oven will adjust itself to the proper settings for the lubrication.

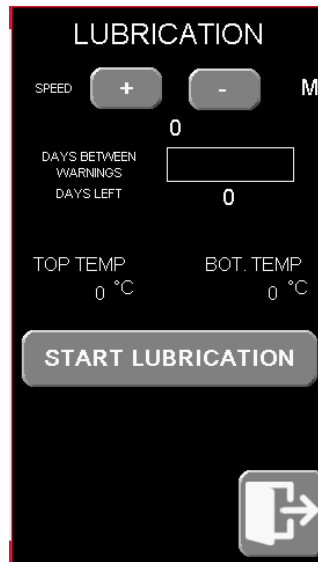

2. For best results and avoid oil spillage wait about 30 minutes to let the oven reach these settings.
3. Shake the lubricant bottle for 2 minutes. This food grade lubricant is designed for Hot Rocks application. No other lubricant will provide adequate lubrication. Using a different lubricant will remove the warranty on parts that require “EXTREME TEMPERATURE FOOD GRADE LUBRICANT”.
4. Make sure the oven is cool before starting this procedure.
5. Remove the top end cover. The entry or exit conveyor can be removed too for easiest reach.

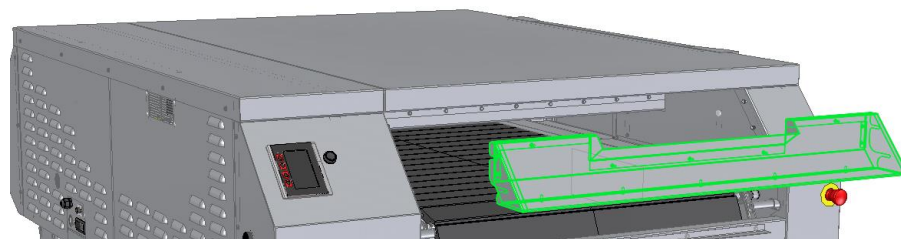

6. Apply lubricant (FO75-0050) to each link of the chain as shown by a yellow strip in the illustration below. Repeat the process for the other chain of the stone conveyor. There are 6 months worth of lubricant in each container.

Lubrication illustration

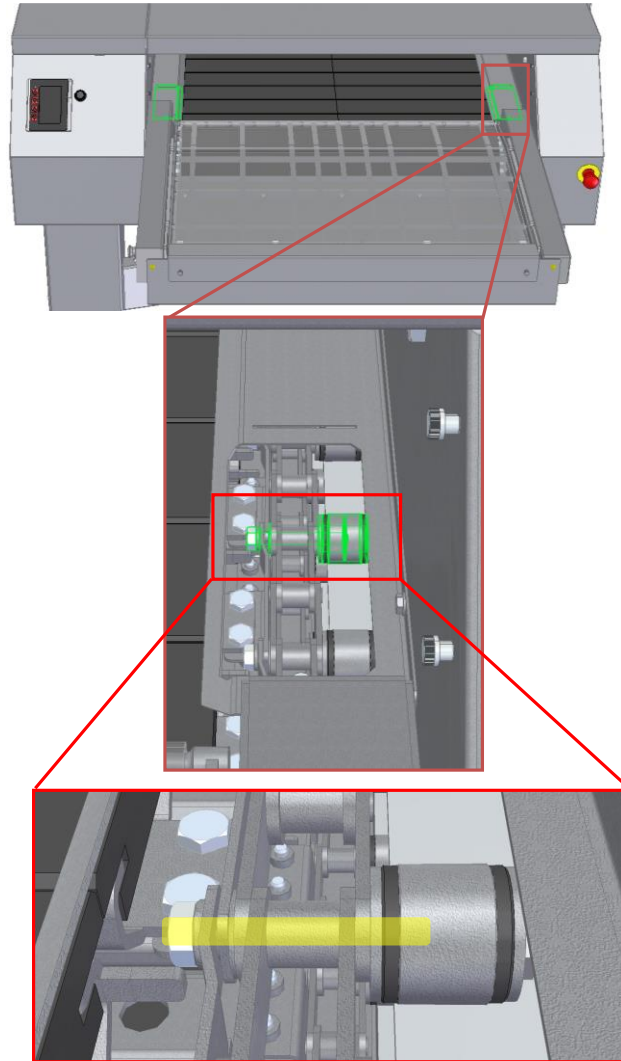

7. After applying lubricate to both sides of the conveyor, leave the oven working 30 minutes to let the oil evaporate.
8. Reinstall the removed panels and operate the oven as usual. Depending on the amount of lubricate applied the excess lubricant will evaporate. The evaporation will produce a temporary odorous non-toxic smell and vapor.

5.1.9 HMI Battery Replacement

The screen of the oven contains a small lithium battery only to retain clock memory. The loss of this battery doesn't affect the oven functionality. This battery needs to be changed each 3 years approximately. If the battery is due, a small low battery red icon will appear as shown below. Contact your service technician to replace it during the next maintenance. Refer to the technician manual for the procedure.

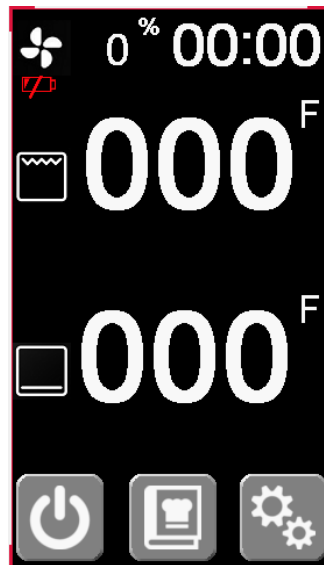

5.1.10 Maintenance Calendar

Technician's preventive maintenance chart																		
Recurrence (Month)	6	12	18	24	30	36	42	48	54	60	66	72	78	84	90	96	102	108
Maintenance #1																		
Maintenance #2																		
Recurrence (Month)	114	120	126	132	138	144	150	156	162	168	174	180	186	192	198	204	210	216
Maintenance #1																		
Maintenance #2																		

Maintenance #1 = 6 Months

Includes: Oiling the main conveyor, greasing all the other chains and bearings and cleaning the electrical panel.

Maintenance #2 = Yearly

Includes : The 6 month maintenance and replacing the ignition rods



6 USA & Canada Sales Conditions and Limited Warranty

Hot Rocks Ovens inc. warrants to the original owner that this equipment is to be free from material or manufacturing defect under normal use for a period of (5) five year on parts and (1) one year on labor from the date of the original installation at the end user location. All warranty service must be performed by a Hot Rocks Ovens pre-approved service company.

Warranty call procedures:

Business hours are from 8h30 am to 5pm (Eastern Time): **(please note our office close at 4pm on Friday)**

Please call our office and ask for the service department (1-855-395-5252 or service@hotrocksoven.com). The service department will issue a work order number and will then contact one of our pre-approved service company.

Outside Business hours and holidays:

Please call the factory (1-855-395-5252). You will be redirected to a service company of your region or to our 24/7 technical support.

Customer's responsibilities:

- The customer must inspect the equipment and crates when they are delivered.
- Damage during transportation must be reported directly to the freight company and to Hot Rocks Ovens.
- The original owner must be present on site during installation day. Any damage to the oven during installation must be reported to Hot Rocks Ovens in a timely manner. Damages during installation will be claimed to the installation company. Hot Rocks Ovens has no obligation to cover those damages.
- When the installation of the Hot Rocks Ovens equipment is made by an authorized dealer or any other person than one of Hot Rocks Ovens employees, even in the presence of a Hot Rocks Ovens supervisor, the dealer or person installing shall be the only person responsible of any faulty installation of the equipment, no warranty being given by Hot Rocks Ovens on an installation performed by any person other than one of Hot Rocks Ovens' own employees. No labor warranty applies in such cases.
- All necessary utilities must be installed in respect of the local building code by a licensed contractor and ready at start up.

Warranty conditions and Limitations of Liability:

This warranty is valid only upon the following terms:

- All installations must be made by Hot Rocks Ovens' authorized service technicians and in accordance with the instructions supplied with the unit. The customer must give proof of the installation and the initial start-up
- Terms of payment have been met.
- The equipment has not been accidentally or intentionally damaged, altered, misused or abused.
- Warranty coverage is at the sole discretion and is the exclusive right of Hot Rocks Ovens.
- Warranty replacement parts will be sent out under the authority of Hot Rocks Ovens, prepaid freight, expedited in the most rapid manner possible. It is the responsibility of the customer to return all defective parts as requested by Hot Rocks Ovens, prepaid freight, for proper warranty credit to be issued.
- Installations not within the applicable building or fire codes render this Limited Warranty and any responsibility or obligations associated therein null and void.
- Hot Rocks maintains the right to not apply the warranty if proper maintenance has not been performed on the oven and might require proof of maintenance (parts and/or labor invoices).
- Warranty is not transferable.

In the event of a warranty claim, the sole obligation of Hot Rocks Ovens shall be to repair and / or replace equipment or equipment components, at their own discretion. Such repair or replacement shall be at the expense of Hot Rocks Ovens with the exception of travel over 160 miles or two hours, overtime and holiday charges which shall be at the customer's expense. Any repairs or replacement of parts or equipment, under this warranty will be covered for the remaining period of the warranty or 90 days, whichever is the longest.

Hot Rocks Ovens liability on any claim of any kind, including claims based on warranty, expressed or implied, contract, negligence, strict liability or any other theories shall be solely and exclusively the repair or replacement of the product as stated herein, and such liability shall not include, and purchaser specifically renounces any rights to recover, special, incidental, consequential or other damages of any kind whatsoever, including, but not limited to, injuries to persons or damage to property, loss of profits or anticipated profits, or loss of use of the product.

Damages are limited to the original purchase price of the equipment.

Exclusions:

Warranty does not apply in the following cases:

- Any damage incurred during shipping.
- Usage of any high pressure cleaning equipment will void this warranty.
- Air and gas burner adjustments.
- Fuse replacement.
- Retightening of screws and fasteners;
- Normal cleaning and maintenance functions: including lubrication or greasing.
- Parts that would normally wear or need replacement under normal use (example: light bulbs, fuses, interior and exterior finishes, granite stone, ignition rod and wires, wire mesh belts and filters).
- Damages incurred through an Act of God.
- In the event that:
 - There is failure or malfunction of the equipment or any components caused by abnormal or improper use of said equipment or if the failure is otherwise not attributable to a material or manufacture defect.
 - Any failure caused by improper use.
 - The equipment has been altered from its original factory condition.
 - The rating plate has been removed, altered or obliterated.
 - The equipment has been improperly maintained. Proper maintenance is the responsibility of the customer.
 - Any parts that become defective because of utilities services including, but not limited to power surges, out of range voltage, out of range gas pressure, contaminated fuel, improper utility connections, improper ventilation / makeup air.

This warranty shall not apply if the equipment or any part is damaged as a result of accident, casualty, alteration, misuse, abuse, improper cleaning, improper installation, improper operation including, but not limited to improper oven loading, natural or manmade disasters. In no event shall Hot Rocks Ovens be held liable for direct, incidental or consequential damages arising out of or resulting from the operation of this equipment.

Hot Rocks Ovens assumes no liability for any contingent or consequential damages incurred by the customer, including but not limited to down time, loss of business, damage or product loss.

In the event that the customer denies access to an authorized technician, whom has been scheduled to make a service call, upon their arrival, the customer releases Hot Rocks Ovens from of any and all warranted obligations and all expenses incurred from that date forward are the sole responsibility of the customer.

Note: Oven facades, windows, light bulbs, granite or baking stones are not covered under this warranty.

In case of any litigation or claim whatsoever regarding this Limited Warranty, the only competent courts shall be the ones of the judicial district of Drummondville, province of Quebec, Canada. This Limited Warranty and all sales agreements for the equipment shall be construed, interpreted and executed in accordance with the laws in force in the province of Quebec, Canada.

Contact information:

Telephone: 819-395-5151



Toll Free: 1-855-395-5252

Fax: 819-395-5343

Email: info@hotrocksoven.com

7 PIZZA RECIPES

All kinds of pizzas can be baked in the Hot Rocks oven. Here are some recipes that can use as a guideline to find the perfect baking setup for your own style of pizza. (see 7-0079)

	Topping temperature	Crust temperature	Convection speed	Cooking time
NEW YORK STYLE 	570°F	420°F	80%	6:30 minutes
NEAPOLITAN STYLE 	690°F	540°F	100%	5:00 minutes
CALZONE 	570°F	420°F	80%	8:00 minutes
STROMBOLI 	570°F	420°F	80%	8:30 minutes
SCREEN PIZZA 	580°F	420°F	85%	7:15 minutes

	Topping temperature	Crust temperature	Convection speed	Cooking time
PAN PIZZA 	530°F	380°F	70%	9:00 minutes
DETROIT STYLE 	520°F	450°F	75%	12:30 minutes
GRANDMA SICILIAN PIZZA 	510°F	380°F	60%	10:45 minutes
CHICAGO THIN CRUST 	530°F	380°F	70%	7:30 minutes
CHICAGO DEEP DISH 	530°F	380°F	70%	15:00 minutes



2555, Alfred Nobel, Drummondville
(Québec) Canada J2A 0L5
T : 819 395-5151 / 855 395-5252
F : 819 395-5343
hotrocksoven.com

Follow-us

